

**CONOTECH**

Precision without compromise



# **NIGHT ARROW**

## **Thermal Imaging Riflescope**

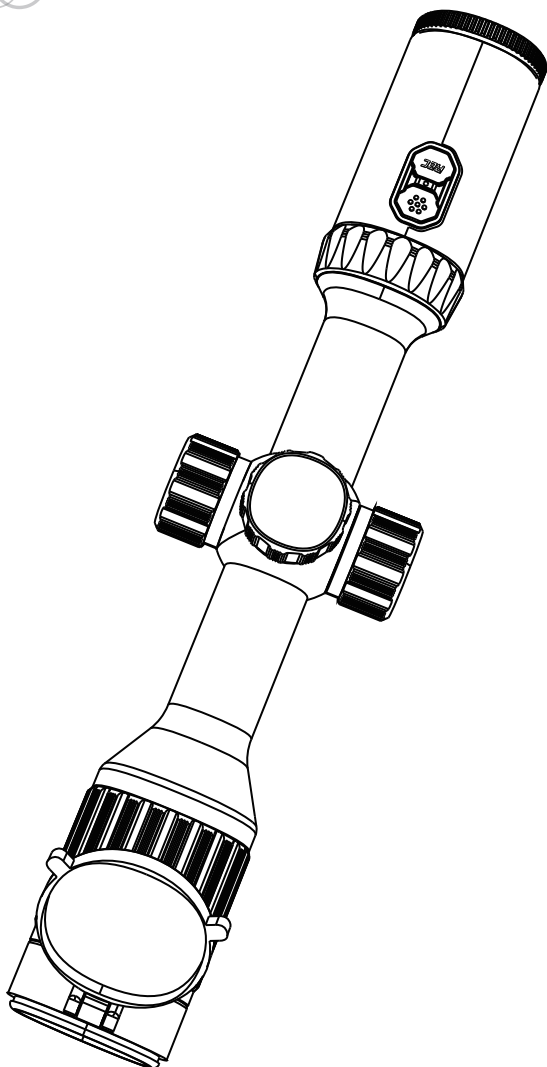

### **Attention!**

Export of **Night Arrow Series** models may have export restrictions depending on the laws in your region.

RoHS  

## Attention!



The proper usage of the device is important for safe exploitation! Therefore, reading carefully the present manual!



If the device was left in storage for a longer period of time, before exploitation check its functionality.



Disassembling of the device is prohibited, except in authorized repairing centers.



The external optical surfaces should be clean at all times. Touching the optical surfaces with bare hands is not recommended.



Sand and sea water can damage the optical coatings!



Do not point the device directly at the sun!



Image performance is dependent on scenery and atmosphere conditions. Contrast in the same image may vary as a function of the time of day due to the effect of the sun. For example, at sunset objects will have absorbed different levels of heat resulting in greater temperature differences and better contrast.



When left in storage for a longer period of time, batteries have to be removed and stored in polyethylene bags to prevent contact with metal. (It is recommended to recharge the batteries every two to three months)



When carrying or transporting the device, put the protective lens cap!



Condensation can cause fogging of the optical surfaces!  
Condensation occurs when the temperature or humidity changes as follows:

- When moving the device from cold to warm place or vice versa
- In places with high humidity

When equalizing the temperature of the device with the environmental, the condensation disappears. Use the towel to remove moisture.



Clean the lens surfaces with the lens cloth or with the napkin!



### LEGAL NOTICE

Before attaching to weapons, check the regional legal regulations in the area of application.  
The attachment to a weapon is always the sole responsibility of the user.

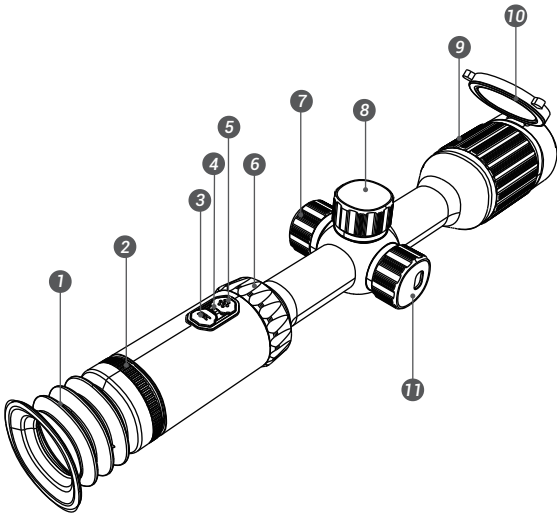

**NOTE**

All images used in this instruction manual are for illustrative purpose only. Actual product may vary due to product enhancement.(v.5.0)

- 1** Rubber eyepiece
- 2** Diopter adjustment ring
- 3** REC button
- 4** LED indicator
  - 🔴 Charging: Red light flashes
  - 🟢 Full power: Green light is steady on
  - 🔴 Low power: Red light is steady on
  - 🟢 Wifi on: Green light flashes quickly
  - 🟢 Wifi connects successful: Green light turns on for 3s and turns off
  - 🟢 USB connects: Green light flashes
- 5** MENU button
- 6** Rotating wheel
- 7** Battery compartment cap
- 8** Controller
- 9** Focus ring
- 10** Lens cover
- 11** USB-C

## 1.Controller

O - OFF  
I - ON  
S - Standby

## 5.Rotating Wheel :

### Real-time image status:

Rotate counterclockwise:  
Zoom out  
Rotate clockwise:  
Zoom in

### Menu activation status:

Rotate counterclockwise:  
Left switch  
Rotate clockwise:  
Right switch

## 2.Menu Button:

### Real-time image status:

Short press: Filter switch  
Long press: Enter menu

### Menu activation status:

Short press:  
Switch menu options  
Long press: Exit menu  
/Enter or Exit submenu

## 4.REC + Menu Button :

Calibration

## 3.REC Button:

### Real-time image status:

Short press: Take photo  
Long press: Start/Stop video recording

### Menu activation status:

Short press: Switch menu options

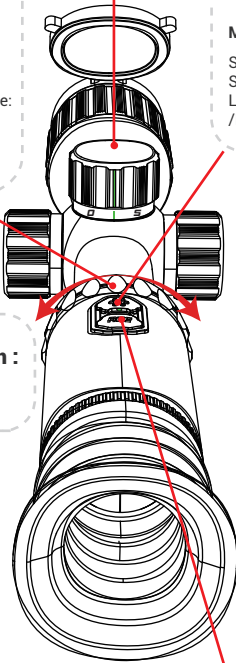

The status bar is on the top and bottom of the display and shows information on the actual operating status of the NIGHT ARROW.

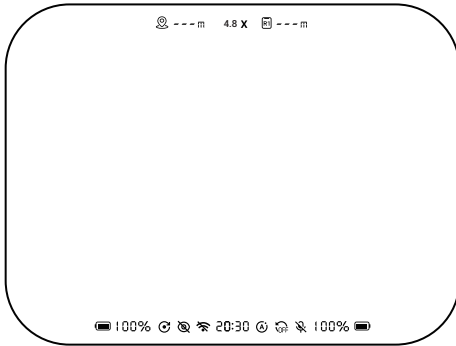

The top of the display shows information including:

- Distance
- Magnification
- Rifle Profile
- Zeroing Distance

The bottom of the display shows information including:

- External Battery Battery
- External Battery Capacity
- Recoil Video
- Display Mode
- WIFI Status
- Real Time
- Calibration Mode
- Standby Setting
- Audio
- Built-in Battery Capacity
- Built-in Battery Battery

## Take photo/recording on-board

Short press **REC** button to take photo.

Long press **REC** button to start/stop video recording.

Number of photos or recording icon will be shown on the left top of the screen.

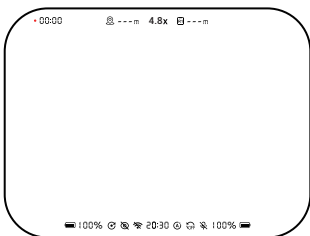
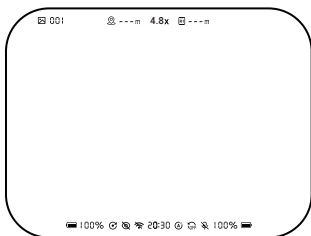

## Firmware update via APP

Easily keep your device at the forefront of technology with firmware updates directly through our dedicated app.



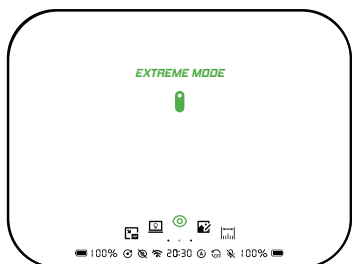



## **Extreme mode**

Short press **MENU/REC** button to turn Extreme mode On/Off.

## **Image Equalizer**

Short press **MENU/REC** button to select:

-  **Brightness** Rotate the wheel to change the Brightness value from 1-5
-  **Contrast** Rotate the wheel to change the Contrast value from 1-5
-  **Sharpness** Rotate the wheel to change the Sharpness value from 1-5

## **Rangefinder**

### Stadiametric rangefinder

(only in NAR 335PRO/NAR 350PRO/NAR 635PRO/NAR 650PRO)

NIGHT ARROW is equipped with a stadiametric rangefinder which allows the user to estimate approximate distance to an object of known size.

Short press **MENU/REC** button to enter Rangefinder.

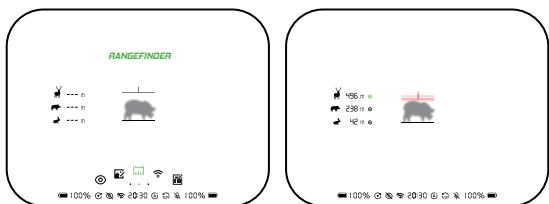

You will see on the display: measurement bars, icons of three reference objects and respective distances for the three objects.

There are three pre-set reference objects:

Rabbit – height 0.2m

Wild boar – height 0.5m

Deer – height 1.7m

Please move lower fixed bar to the bottom of the object, then rotate the wheel to move down/up of the upper line to the top of the object. The distance of the object is automatically recalculated as you move the upper line.

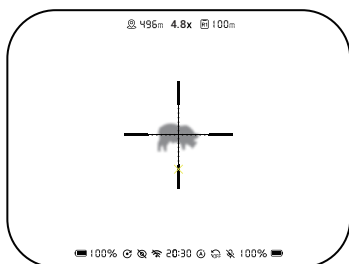

Press the **MENU/REC** button to choose reference object. Long press **MENU** to save & exit the rangefinder, the range information will not disappear from the display automatically.

A "X" on reticle suggests the aiming point accordingly.



## **Laser rangefinder** (only available in NAR LIIR series)

Short press **MENU/REC** to enter the laser rangefinder selection, and rotate the wheel to turn on single ranging or continuous ranging. But only one can be turned on at a time.

-  Single ranging
-  Continuous ranging

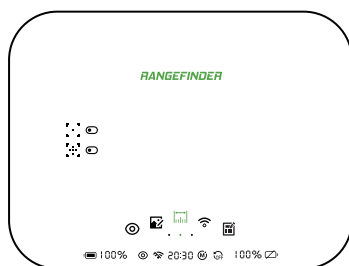

Short press **MENU** and the distance will be shown in the top left screen.

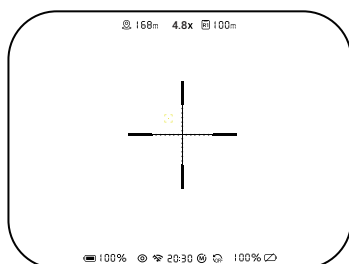

For an enhanced user experience, please first complete the zeroing process, followed by finalizing the Ballistic Calculate parameter settings.

When the continuous ranging is turned on, the relevant distance will show up. A "X" on reticle suggests the aiming point accordingly.

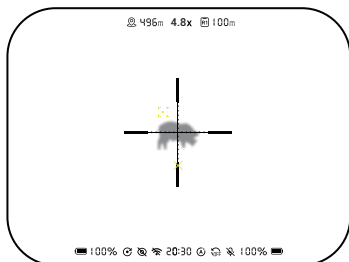

## **WIFI**

Short press **MENU/REC** button to turn WIFI On/Off.

## **Ballistic Calculator**

Short press **MENU** to enter Ballistic calculator. Then rotate the wheel to turn on/off the function. Short press the **MENU/REC** to select Ballistic data, Velocity, Wt, Bullet BC, Drag Model, Scope Ht, and Zero range, then rotate the wheel adjust the value matching your rifle. Long press **MENU** to save and exit.

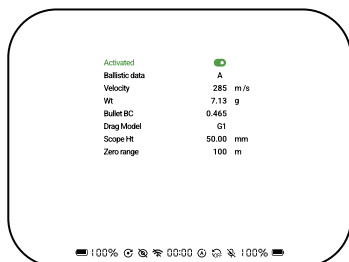

**Ballistic data** - Maximum storage capacity for 5 types of bullets.

**Velocity, Wt, Bullet BC** - On the bullet package or ask the bullet supplier.

**Drag Model** – G1 for short, flat-based bullets, G7 for long bullet with a boat-tail and pointy nose.

**Scope Ht** - The distance from the center of the weapon barrel to the center of the lens.

After entering the ballistic calculation parameters, please ensure to perform zeroing to enable precise usage.

### **For NAR LIIR series**

Step 1: Short press on **MENU** button - Distance is measured and displayed, the ranging cursor appears.

Step 2: Short press on **MENU** button - Distance is measured and displayed, the aiming point appears, and the ranging cursor appears.

Step 3: Short press on **MENU** button - Distance is measured and displayed, the aiming point disappears, and the ranging cursor appears.

If the interval between button presses does not exceed 30 seconds, steps 2 and 3 will repeat. If the interval between button presses exceeds 30 seconds, the laser rangefinder will stop operating, the ranging cursor will disappear, and the device will remain in its last state. Pressing the MENU button for a single measurement will restart the process from step 1.

Please note: When turn on Ballistic Calculator, continuous ranging is disabled, only single ranging is available.

#### For NAR Pro series

After entering the ballistic calculation parameters, please long press MENU to return to the home page. Suggested aiming points for different distances will appear on the screen.

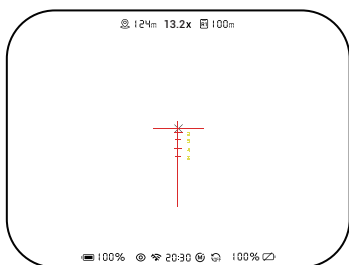

## Profile

NIGHT ARROW can maximize save 3 profiles of rifles.  
Short press **MENU/REC** button to select R1, R2 or R3.  
Long press **MENU/REC** button to save and exit.



## Zeroing

Select the zeroing profile, R1 is set as default. The zeroing distance is set in Ballistic calculator.

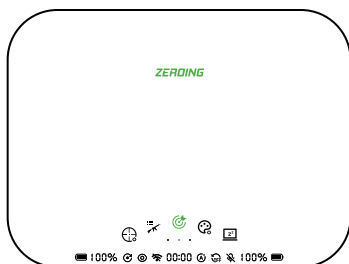

Take a shot, make the cross center of the reticle at point of impact. Short press **MENU/REC** button to switch zeroing options.

### Windage/Elevation

Then rotate the wheel to adjust the X,Y value.

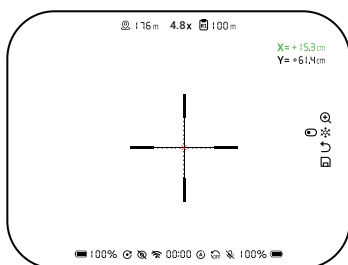

### Zoom

Short press **MENU/REC** button to select zoom function, then rotate the wheel to zoom in/out the reticle.

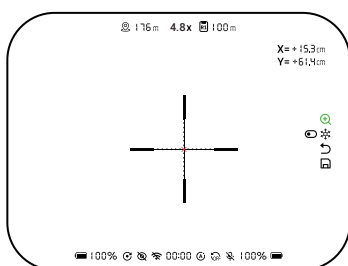

### Freeze

The feature of the freeze function is that there is no need to constantly keep the riflescope at the point of aiming.

After shooting, the user needs to align the dividing center point with the center of the cross target, and then rotate the wheel to freeze the infrared image of the current frame, as shown in the following figure.

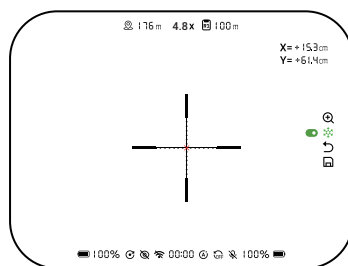

When freezing the image, you can short press **MENU/REC** button to adjust the X value and Y value.

Then you can rotate the wheel to unfreeze the image. Long press **MENU/REC** to save.

## Back

Long press the **MENU** button to return to the previous menu, the current settings will not be saved.

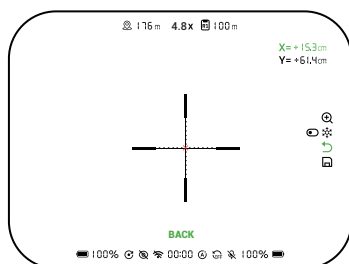

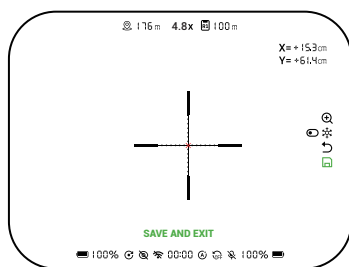

## Save and exit

Long press the **MENU** button to save and exit.



## **Reticle**

 **Brightness** Short press **MENU/REC** to enter the brightness selection, and rotate the wheel to select the value from 1-5. Long press **MENU** to save and exit.

 **Color** Short press **MENU/REC** button to enter the color selection, and rotate the wheel to select the desired reticle color, including Green, Red, White, and Black. Long press **MENU** button to save and exit.

 **Type** Short press **MENU/REC** button to enter the reticle type selection and rotate the wheel to select one from 4 reticle types. Long press **MENU** button to save and exit.

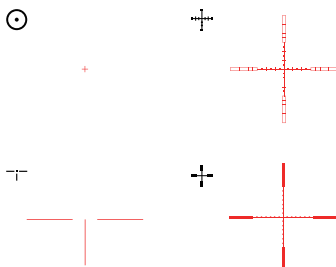

## **Recoil video**

Short press MENU/REC to turn on/off the function. The pre-recording function activates upon detecting recoil, capturing a 10-second span before and after your shot.

## **Microphone**

Short press MENU/REC to turn on/off the microphone.

## **Calibration Mode**

Short press MENU/REC button to choose the calibration mode and long press MENU button to save and exit.

 **Automatic**

 **Manual**

 **Silent** (Please close lens cap when calibrating)

## **Defective Pixel Repair**

Cover objective lens then short press MENU button to perform defective pixel repair. A three-second countdown will appear on the screen, and the calibration will be started.

## **Pure Mode**

Short press MENU/REC button to turn Pure Mode On/Off. The icons of submenu will be hidden automatically.

## **Color Mode**

Short press MENU/REC button to switch through the color modes.

Rotate the wheel to select activated or deactivated current color modes.

Color Modes can be selectively deactivated. Deactivated color modes will not show up so you only cycle through modes that you find useful.

The available Color Modes are:

WH - White Hot    BH - Black Hot    WW - Warm White  
CG - Cold Green    CB - Cold Blue    RB - Rainbow

## **Standby Setting**

Short press MENU/REC button to switch the option from    



## Advanced Settings

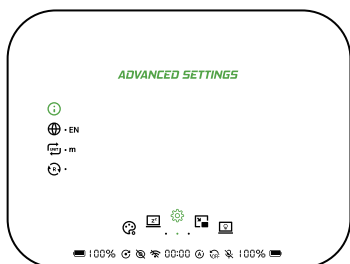

**Device Info** Contain Model, S/N, software version and hardware version.



**Language** Rotate the wheel to select from EN/DE/RU/CZ/ES/SE/PL, long press **MENU/REC** button to save and exit



**Unit** Rotate the wheel to select from Meter and Yard, long press **MENU/REC** button to save and exit.



**Restore** Rotate the wheel to select YES/NO, long press **MENU** button to save and exit.



## PIP

Short press **MENU/REC** button to turn PIP On/Off.



## Screen Brightness

Press **MENU/REC** button to enter and rotate the wheel to change the value from 1-5, long press **MENU** button to save and exit.

## Removable battery

The batteries should be charged before first use.  
Turn the battery compartment knob counterclockwise until stop.

Please install the battery based on the positive and negative signs.  
Otherwise, NIGHT ARROW will not start.

Replace the battery and close the compartment knob.

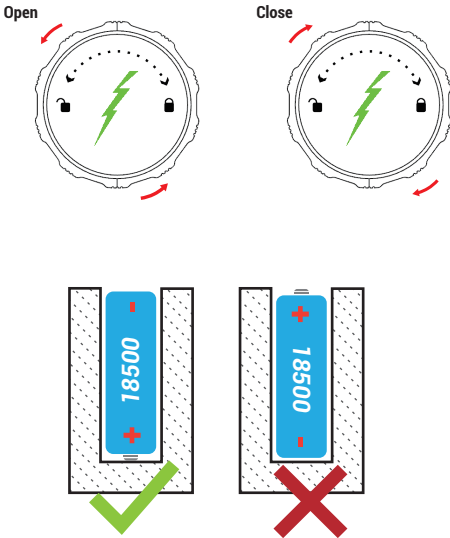

## Built-in battery

NIGHT ARROW is powered by built-in rechargeable battery of total 6400 mAh and 1 removable 18500 battery.

1.If there are built-in battery and removable battery in the device, two battery icons are displayed in the status bar. The removable battery capacity shows on the left bottom of the status bar, and the built-in battery capacity shows on the right bottom.

2.When both type of batteries are fully charged, the device is powered by the removable battery. If there is low removable battery level, the device will switch to the built-in battery.

3.Battery charge status is displayed on the status bar.

	100%	90%	80%	70%	60%	50%	40%	30%	20%	10%	No battery	Charging
Removable Battery Capacity												
Built-in Battery Capacity												

4.It is possible to replace removable battery while NIGHT ARROW is on when it is powered by built-in battery (the device will continue to work properly).

## External power supply

External power can be supplied from an external source, such as a power bank.

1. Connect the external power supply to the USB-C cable.
2. NIGHT ARROW takes to external power source while the built-in battery will gradually be recharged.
3. A rechargeable battery icon indicating a percentage of the battery life will appear in the status bar .
4. NIGHT ARROW supports quick fully charge in only 3 hours.
5. When you turn off external power source, NIGHT ARROW takes power from removable battery without turning off. When there is no removable battery or low power level the device takes power from the built-in battery.

### **NOTE**

The batteries should be charged before first use.

When installing a removable battery with a sufficient charge level, NIGHT ARROW will automatically switch to it.

Zeroing information will be saved when NIGHT ARROW is shut down because of empty battery.

If NIGHT ARROW is shut down by opening battery cover without proper power off, zeroing information will not be saved.

### 1. Power supply/Firmware update/Charge built-in battery

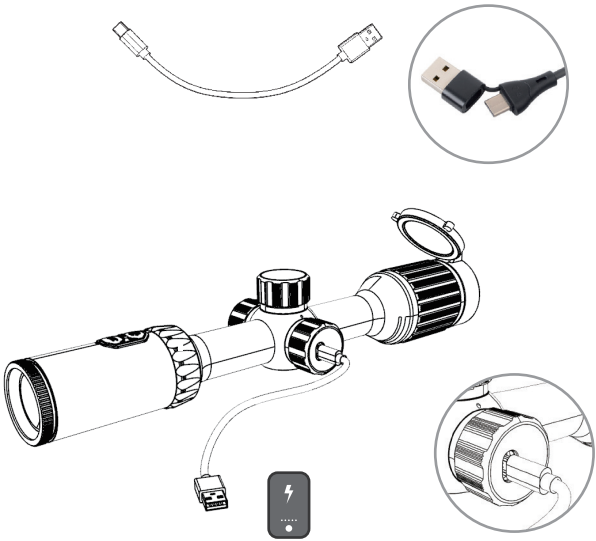

## Attach to rifle

To ensure accurate shooting NIGHT ARROW should be properly mounted on the rifle.

Mount NIGHT ARROW with 30mm scope rings. Use only high-quality mounts and rings compatible with your rifle. Follow the mount manufacturer's installation instructions and use the proper tools.

When mounting NIGHT ARROW, adjust the position of the scope on the rifle to achieve optimal, comfortable eye relief. Failure to comply with this recommendation may result in injury to the shooter.

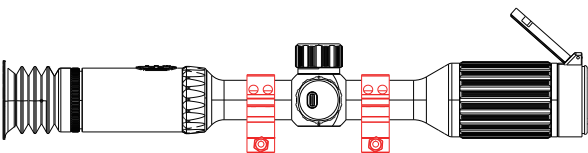

## Storage and Transportation

- Before storing it, clean obligatory the device.  
(In case of moisture, dust or traces of dirt on its surface )
- Make sure that there are no traces of moisture, and the battery compartment is empty!
- It is also possible for a short period of time device to be stored in a suitable soft pack, bag or cartridge box.
- The premises in which the device is kept for long term have to be dry, enclosed, unheated and ventilated.
- During the storage should not be allowed exposure to aggressive environments, temperatures below  $-50^{\circ}\text{C}$  and above  $+60^{\circ}\text{C}$ , relative humidity greater than 80%, and prolonged periods of direct sunlight.
- Before each transportation, the product should be neatly packed in its original packaging (transport bag) and all other items and accessories should be carefully and steadily placed in the bag.
- You can ship the product with all types of transport at different distances and at altitude up to 12000m.

**Night Arrow Specification**

Model	NAR 335PRO	NAR 350PRO	NAR 350LIIR	NAR 635PRO	NAR 650PRO	NAR 650LIIR
<b>Main Characteristics</b>						
Detector	Uncooled Vox					
Resolution	384×288			640×512		
Frame rate	50Hz					
Pixel	12μm					
Spectral range	8-14μm					
NETD	<20mk					
<b>Optical Characteristics</b>						
Objective lens	35mm	50mm	50mm	35mm	50mm	50mm
Magnification	3.3x	4.8x	4.8x	1.9x	2.7x	2.7x
FOV(HxV), m@100m	13.2×10	9.2×7	9.2×7	22×18	15.4×12.3	15.4×12.3
Close-up range	3m					
Dioptr adjustment	±5D					
<b>Detection Range</b>						
Detection distance (Target size: 1.7m×0.5m, P(n)=99%)	2480m	3540m	3540m	2480m	3540m	3540m
<b>Functions</b>						
Zoom	1X/2X/4X			1X/2X/4X/8X		
Palettes	6					
Firmware update via APP	Yes					
<b>Display</b>						
Type	OLED					
Resolution	1024×768					
External video	WIFI					
Built-in memory	32GB					
<b>Power Supply</b>						
Battery	2×18650 (Built-in battery) + 1×18500 (External battery)					
External power supply	5V-2A, 9V-2A (USB Type-C)					
Operating time (at t=22°C)	12h					
<b>Physical Characteristics</b>						
Weight (without external battery)	900g	950g	990g	900g	950g	990g
Dimension	72×89×375mm	72×89×390mm	72×89×380mm	72×89×375mm	72×89×390mm	72×89×380mm
<b>Environmental Compatibility</b>						
Ingress protection rating	IP67					
Operating temperature	-20°C -50°C					
Storage temperature	-40°C -60°C					
Shock resistance	1200g,1ms					
<b>Laser Rangefinder (Only available in NAR 650LIIR)</b>						
Safety class for laser equipment according to IEC 60825-1:2014	/		1	/		1
Measuring range	/		5-1200m	/		5-1200m
Measurement accuracy	/		± 1m	/		± 1m